

# MODELLI DI COPPIA

1) Famiglia tradizionale

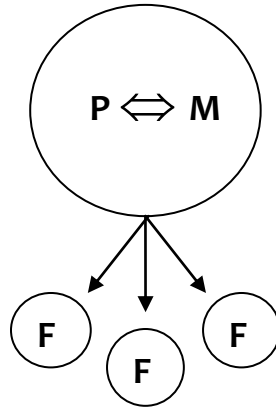

3) Monarchia costituzionale

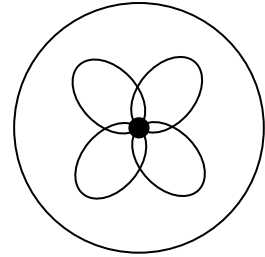

2) Monarchia assoluta

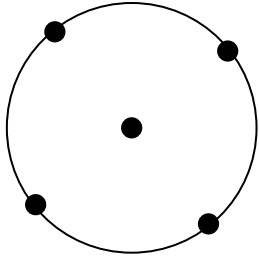

5) Anarchia

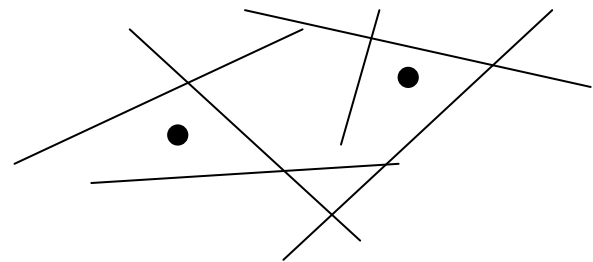

4) Democrazia

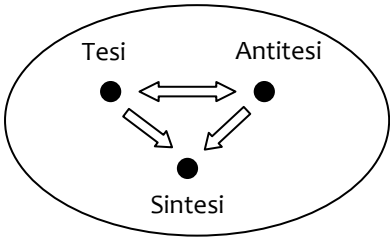

## RAPPORTI NELLA COPPIA

1) Relazione simmetrica

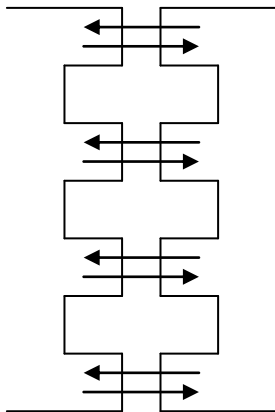

Rischio  
di continua competitività

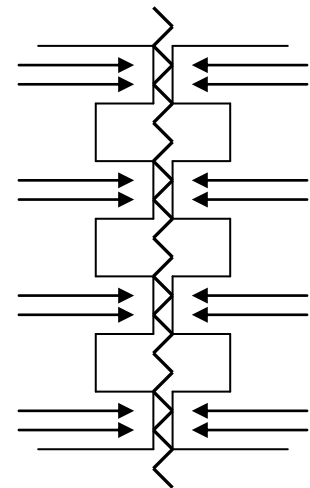

2) Relazione complementare

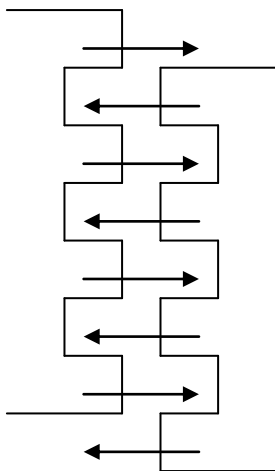

Rischio  
che uno diventi dominante

